

wineo

THAT'S FLOORING

ZUBEHÖR | ACCESSORIES
ACCESSOIRES | ACCESORIOS

INHALT

CONTENT | CONTENU | CONTENIDO

Fußleisten Skirting boards Plinthes Zócalos	05
Unterlagsmaterial Underlay material Sous-couche Material base	22
Akzentstreifen Feature strips Joints effet carrelage Franjas decorativas	31
Hochzüge, Außenecken & Schmelzdrähte Skirting boards, external corners & weld rods Remontées, angles extérieurs & Cordons de soudures Rodapiés, esquinas exteriores & cordones des soldadura	32
Aluminiumprofile in Holz- und Metalloptik Aluminium Profiles in wood and metal finish Profilés aluminium aspect bois et métal Perfiles de aluminio en optica de maderay y métal	36
Verlegeutensilien & Reparaturartikel Installation tools & repair products Ustensiles de pose & articles de réparation Utensilios de instalación y artículos de reparación	42

SYSTEMATIK

SYSTEM | SYSTÉMATIQUE | SISTEMÁTICA

Grün steht für wineo PURLINE Bioboden; Zubehör, dass grün gekennzeichnet ist, passt zu wineo PURLINE Bioboden
Green symbolizes wineo PURLINE Organic Flooring; Accessoires which are marked in green are suitable for wineo PURLINE Organique Flooring | Vert es la couleur de wineo PURLINE Sol Organique; les accessoires qui sont marquer en vert vont bien avec les produits de wineo PURLINE Sol Organique | Verde es el color de wineo PURLINE Suelo Bio; los accesorios que están junto al color verde pertenecen a wineo PURLINE Suelo Bio

Pink steht für wineo Designboden; Zubehör, dass pink gekennzeichnet ist, passt zu wineo Designboden
Pink symbolizes wineo Design Flooring; Accessoires which are marked in pink are suitable for wineo Design Flooring
Pink est la couleur de wineo Sol Design; les accessoires qui sont marquer en vert vont bien avec les produits de wineo Sol Design | Pink es el color de wineo Suelo de Diseño; los accesorios que están junto al color verde pertenecen a wineo Suelo de Diseño

Türkis steht für wineo Laminatboden; Zubehör, dass türkis gekennzeichnet ist, passt zu wineo Laminatboden
Turquoise symbolizes wineo Laminate Flooring; Accessoires which are marked in turquoise are suitable for wineo Laminate Flooring | Turquoise est la couleur de wineo Sol Stratifié; les accessoires qui sont marquer en turquoise vont bien avec les produits de wineo Sol Stratéfie | Turquesa es el color de wineo Suelo Laminado; los accesorios que están junto al color turquesa pertenecen a wineo Suelo Laminado

Grau markiertes Zubehör passt zu allen wineo Produkten
Accessoires which are marked in grey are suitable for all wineo products | Accessoires qui sont marquer en gris sont adaptable avec tous les produits de wineo | Accesorios que están junto al color gris pertenecen a todos productos de wineo



FUSSLEISTEN

SKIRTING BOARDS | PLINTHES | ZÓCALOS

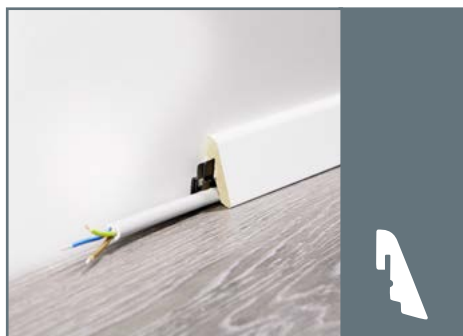

Art. 18,5/38,5 | MDF-Material
18,5 × 38,5 × 2400 mm | Box = 4 ×

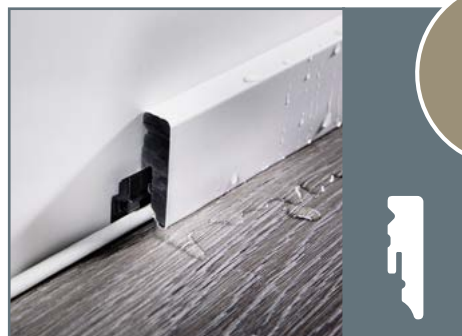

14,5/50 | Recycled-Material
14,5 × 50 × 2400 mm | Box = 4 ×

AQUA
PROTECT

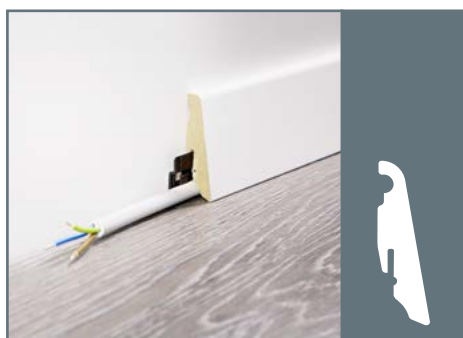

19/58 | MDF-Material
19 × 58 × 2400 mm | Box = 4 ×



15/70 | MDF-Material
15 × 70 × 2400 mm | Box = 4 ×

PRODUCT
IN BLACK AND
WHITE



15/80 | MDF-Material
15 × 80 × 2400 mm | Box = 4 ×



18/115 | MDF-Material
18 × 115 × 2400 mm | Box = 4 ×

Clipholder- Befestigungssystem

Clipholder fastening
system
 Système de fixation
 Clipholder
 Sistema de fijación
 Clipholder



Art. no. 30020241
 Box = 30 Clips/
 ca. 15 lfm. | rm |
 metros lineales | ml

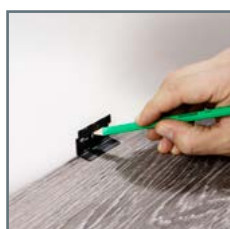

anzeichnen
 mark out
 maquage
 marcar



bohren
 drill
 perçage
 taladrar

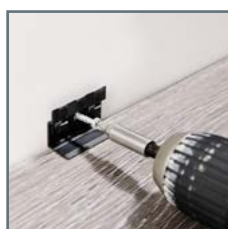

anschrauben
 screw on
 vissage
 atornillar

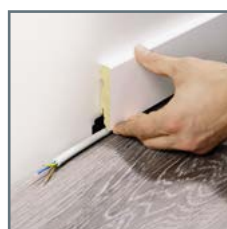



























aufstecken
 put in place
 pose
 colocar

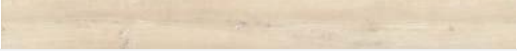

fertig
 done
 c est terminé
 listo

FUSSLEISTEN

SKIRTING BOARDS | PLINTHES | ZÓCALOS

























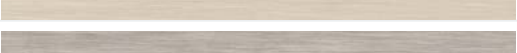

Design	fit to article	
Arctic Oak	PLEW10008 PL008R PLC008R	
Ascona Pine Nature	PL052R PLC052R	
Calistoga Cream	PLEW10004 PL054R PLC054R	
Calistoga Grey	PLEW10003 PL003R PLC003R	
Calistoga Nature	PLEW10001 PL001R PLC001R	
Canyon Oak	PLEW10007 PL007R PLC007R	
Canyon Oak Honey	PL076C	
Canyon Oak Sand	PL075C	
Carmel Pine	PL048R PLC048R	
Classic Oak Autumn	PL073C	
Classic Oak Spring	PL071C	
Classic Oak Summer	PL072C	
Classic Oak Winter	PL074C	
Crafted Oak	PL080C	
Crystal Pine	PL098C	
Dacota Oak	PLEW20017 PL017R PLC017R	
Fashion Oak Cream	PL092C	
Fashion Oak Grey	PL089C	
Fashion Oak Natural	PL091C	
Garden Oak	PLEW10005 PL005R PLC005R	
Golden Pine Mixed	PL077C	
Island Oak Honey	PL043R PLC043R	
Island Oak Moon	PL045R PLC045R	
Island Oak Sand	PL044R PLC044R	
Malmoe Pine	PLEW20019 PL019R PLC019R	
Native Ash	PL099C	
Noble Elm	PL081C	



	18,5/38,5	14,5/50	19/58	15/70	15/80	18/115
Art. No.		30060414				
Art. No.		30060515				
Art. No.		30060410				
Art. No.		30060409				
Art. No.		30060407				
Art. No.		30060413				
Art. No.		30060607				
Art. No.		30060606				
Art. No.		30060516				
Art. No.		30060604				
Art. No.		30060602				
Art. No.		30060603				
Art. No.		30060605				
Art. No.		30060630				
Art. No.		30060628				
Art. No.		30060423				
Art. No.		30060622				
Art. No.		30060623				
Art. No.		30060621				
Art. No.		30060411				
Art. No.		30060608				
Art. No.		30060518				
Art. No.		30060519				
Art. No.		30060520				
Art. No.		30060425				
Art. No.		30060629				
Art. No.		30060611				

FUSSLEISTEN

SKIRTING BOARDS | PLINTHES | ZÓCALOS





















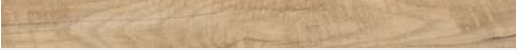





Design	fit to article	
Nordic Pine Modern	PL050R PLC050R	
Nordic Pine Style	PL049R PLC049R	
Patina Teak	PL046R PLC046R	
Polar Pine	PL082C	
Pure Black	PL194C	
Pure Pine	PL079C	
Queen's Oak Amber	PL096C	
Queen's Oak Pearl	PL097C	
Royal Chestnut Desert	PL085C	
Royal Chestnut Grey	PL084C	
Royal Chestnut Mocca	PL086C	
Silver Pine Mixed	PL078C	
Summer Beech	PL047R PLC047R	
Supreme Oak Grey	PL070C	
Supreme Oak Natural	PL068C	
Supreme Oak Silver	PL069C	
Traditional Oak Brown	PL051R PLC051R	
Uptown Pine	PL083C	
Valley Oak Mud	PL042R PLC042R	
Valley Oak Soil	PL041R PLC041R	
Village Oak Brown	PL088C	
Village Oak Cream	PL087C	
Village Oak Grey	PL089C	
Western Oak Cream	PL094C	
Western Oak Desert	PL095C	
Wild Wood	PL100C	



	18,5 / 38,5	14,5 / 50	19 / 58	15 / 70	15 / 80	18 / 115
Art. No.		30060521				
Art. No.		30060522				
Art. No.		30060523				
Art. No.		30060612				
Art. No.		30060598				
Art. No.		30060610				
Art. No.		30060626				
Art. No.		30060627				
Art. No.		30060616				
Art. No.		30060615				
Art. No.		30060617				
Art. No.		30060609				
Art. No.		30060524				
Art. No.		30060601				
Art. No.		30060599				
Art. No.		30060600				
Art. No.		30060525				
Art. No.		30060613				
Art. No.		30060526				
Art. No.		30060527				
Art. No.		30060619				
Art. No.		30060618				
Art. No.		30060620				
Art. No.		30060524				
Art. No.		30060525				
Art. No.		30060614				

FUSSLEISTEN

SKIRTING BOARDS | PLINTHES | ZÓCALOS



















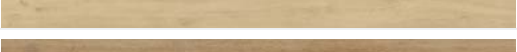







Design	fit to article	
Adventure Oak Rustic	DB00111 DLC00111 MLD00111	
Ambition Oak Calm	DB00122 DLC00122 MLD00122	
Aumera Oak Dark	DB00027 DLC00027	
Aumera Oak Grey	DB00029 DLC00029	
Aumera Oak Native	DB00028 DLC00028	
Aurelia Cream	DB00006 DLC00006	
Aurelia Grey	DB00005 DLC00005	
Aurelia Provence	DB00004 DLC00004	
Calm Oak Cream	DB00010 DLC00010	
Calm Oak Nature	DB00009 DLC00009	
Chateau Brown	DB00002 DLC00002	
Chateau Grey	DB00003 DLC00003	
Chateau White	DB00001 DLC00001	
Clay Calm Oak	DB00062 DLC00062	
Comfort Oak Mellow	DB00129 DLC00129 MLD00129	
Copenhagen Frosted Pine	DB00076 DLC00076	
Corn Rustic Oak	DB00064 DLC00064	
Courage Stone Grey	DB00137 DLC00137 MLD00137	
Cyprus Dark Oak	DB00066 DLC00066	
Desire Oak Light	DB00108 DLC00108 MLD00108	
Embrace Oak Grey	DB00110 DLC00110 MLD00110	
Emotion Oak Rustic	DB00123 DLC00123 MLD00123	
Energy Oak Warm	DB00114 DLC00114 MLD00114	
Fairytale Stone Pale	DB00142 DLC00142 MLD00142	
Fortune Stone Rusty	DB00143 DLC00143 MLD00143	
Glamour Concrete Modern	DB00141 DLC00141 MLD00141	
Grace Oak Smooth	DB00106 DLC00106 MLD00106	



	18,5/38,5	14,5/50	19/58	15/70	15/80	18/115
Art. No.			30060566			
Art. No.			30060575			
Art. No.			30060464			
Art. No.			30060466			
Art. No.			30060467			
Art. No.			30060453			
Art. No.			30060452			
Art. No.			30060451			
Art. No.			30060457			
Art. No.			30060456			
Art. No.			30060449			
Art. No.			30060450			
Art. No.			30060448			
Art. No.			30060540			
Art. No.			30060582			
Art. No.			30060550			
Art. No.			30060542			
Art. No.			30060590			
Art. No.			30060544			
Art. No.			30060563			
Art. No.			30060565			
Art. No.			30060576			
Art. No.			30060569			
Art. No.			30060595			
Art. No.			30060596			
Art. No.			30060594			
Art. No.			30060561			

FUSSLEISTEN

SKIRTING BOARDS | PLINTHES | ZÓCALOS

Design	fit to article	
Harmony Stone Sandy	DB00134 DLC00134 MLD00134	
Helsinki Rustic Oak	DB00068 DLC00068	
Hero Stone Gloomy	DB00138 DLC00138 MLD00138	
Honey Warm Maple	DB00081 DLC00081	
Infinity Dark Solid	DB00073	
Infinity Light Solid	DB00074	
Inspiration Oak Clear	DB00113 DLC00113 MLD00113	
Intuition Oak Brown	DB00130 DLC00130 MLD00130	
Joy Oak Tender	DB00126 DLC00126 MLD00126	
Kindness Oak Pure	DB00125 DLC00125 MLD00125	
Liberation Oak Timeless	DB00128 DLC00128 MLD00128	
Luck Oak Sandy	DB00127 DLC00127 MLD00127	
Lund Dusty Oak	DB00065 DLC00065	
Magic Stone Cloudy	DB00136 DLC00136 MLD00136	
Memory Oak Silver	DB00132 DLC00132 MLD00132	
Miracle Oak Dry	DB00117 DLC00117 MLD00117	
Mud Rustic Oak	DB00063 DLC00063	
Paradise Oak Essential	DB00112 DLC00112 MLD00112	
Patience Concrete Pure	DB00139 DLC00139 MLD00139	
Ponza Smoky Oak	DB00067 DLC00067	
Riga Vibrant Pine	DB00082 DLC00082	
Romance Oak Brilliant	DB00119 DLC00119 MLD00119	
Salt Lake Oak	DB00079 DLC00079	
Santorini Deep Oak	DB00061 DLC00061	
Sardinia Wild Walnut	DB00083 DLC00083	
Scandic Grey	DB00025 DLC00025	
Scandic White	DB00026 DLC00026	



18,5/38,5

14,5/50

19/58

15/70

















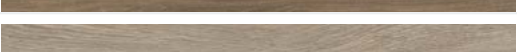

15/80

18/115

Art. No.	30060587
Art. No.	30060546
Art. No.	30060591
Art. No.	30060553
Art. No.	30060548
Art. No.	30060549
Art. No.	30060568
Art. No.	30060583
Art. No.	30060579
Art. No.	30060578
Art. No.	30060581
Art. No.	30060580
Art. No.	30060543
Art. No.	30060589
Art. No.	30060585
Art. No.	30060572
Art. No.	30060541
Art. No.	30060567
Art. No.	30060592
Art. No.	30060545
Art. No.	30060554
Art. No.	30060574
Art. No.	30060551
Art. No.	30060539
Art. No.	30060555
Art. No.	30060462
Art. No.	30060463

FUSSLEISTEN

SKIRTING BOARDS | PLINTHES | ZÓCALOS

Design	fit to article	
Sicily Dark Oak	DB00069 DLC00069	
Silence Oak Beige	DB00124 DLC00124 MLD00124	
Soul Apple Mellow	DB00107 DLC00107 MLD00107	
Spirit Oak Silver	DB00115 DLC00115 MLD00115	
Starlight Oak Soft	DB00116 DLC00116 MLD00116	
Summer Oak Golden	DB00118 DLC00118 MLD00118	
Toscany Pine	DB00007 DLC00007	
Toscany Pine Grey	DB00008 DLC00008	
Valour Oak Smokey	DB00133 DLC00133 MLD00133	
Venero Oak Beige	DB00013 DLC00013	
Venero Oak Brown	DB00014 DLC00014	
Victoria Oak Grey	DB00030 DLC00030	
Victoria Oak Native	DB00031 DLC00031	
Victoria Oak White	DB00032 DLC00032	
Vision Concrete Chill	DB00135 DLC00135 MLD00135	
Wheat Golden Oak	DLC00080 DB00080	
Wisdom Concrete Blue	DB00140 DLC00140 MLD00140	
Wish Oak Smooth	DB00131 DLC00131 MLD00131	
Woodstock Cream	DB00024 DLC00024	
Woodstock Honey	DB00023 DLC00023	

**18,5/38,5****14,5/50****19/58****15/70****15/80****18/115**

Art. No. 30060547

Art. No. 30060577

Art. No. 30060562

Art. No. 30060570

Art. No. 30060571

Art. No. 30060573

Art. No. 30060454

Art. No. 30060455

Art. No. 30060586

Art. No. 30060458

Art. No. 30060451

Art. No. 30060467

Art. No. 30060458

Art. No. 30060469

Art. No. 30060588

Art. No. 30060552

Art. No. 30060593



























Art. No. 30060584

Art. No. 30060461

Art. No. 30060460

FUSSLEISTEN

SKIRTING BOARDS | PLINTHES | ZÓCALOS























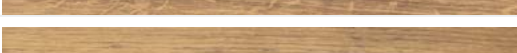



Design	fit to article	
Acacia	LA022M LA022MC	
Alaska Oak	LA054LV2	
Alder Romantic	LA033M LA033MC	
American Pecan	LA055LV2	
Ascona Pine Grey	LA018 LA018C LA018MV2	
Ascona Pine Nature	LA036M LA036MC LA036MV2	
Avenue Oak	LA015 LA015C	
Beech Natural	LA003 LA003C	
Bergamo Oak	LA032M LA032MC	
Californian Oak	LA006 LA006C	
Canadian Maple	LA001 LA001C	
Classic Beech	LA004 LA004C	
Classic Cherry	LA011 LA011C	
Classic Oak	LA010 LA010C	
Coastal Oak	LA028M LA028MC	
Columbian Beech	LA056LV2	
Cornish Oak	LA030M LA030MC	
Country Oak	LA052LV2	
Denali Pine	LA063XLV4	
Garden Oak	LA027M LA027MC	
Globetrotter	LA023M LA023MC	
Husky Oak	LA038M LA038MC	
Kahlua Oak	LA029M LA029MC	
Lumber Grey	LA035M LA035MC	
Lumber White	LA017 LA017C	
Malmoe Pine	LA064XLV4	
Mexican Oak	LA031M LA031MC	



	18,5 / 38,5	14,5 / 50	19 / 58	15 / 70	15 / 80	18 / 115
Art. No.	30030320			30040372		
Art. No.	30030353			30040405		
Art. No.	30030331			30040383		
Art. No.	30030354			30040406		
Art. No.	30030383			30040435		
Art. No.	30030334			30040386		
Art. No.	30030380			30040432		
Art. No.	30030368			30040420		
Art. No.	30030330			30040382		
Art. No.	30030371			30040423		
Art. No.	30030366			30040418		
Art. No.	30030323			30040375		
Art. No.	30030376			30040428		
Art. No.	30030375			30040427		
Art. No.	30030326			30040378		
Art. No.	30030355			30040407		
Art. No.	30030328			30040380		
Art. No.	30030351			30040403		
Art. No.	30030362			30040414		
Art. No.	30030325			30040377		
Art. No.	30030321			30040373		
Art. No.	30030336			30040388		
Art. No.	30030327			30040379		
Art. No.	30030333			30040385		
Art. No.	30030382			30040434		
Art. No.	30030363			30040415		
Art. No.	30030329			30040381		

FUSSLEISTEN

SKIRTING BOARDS | PLINTHES | ZÓCALOS





Design	fit to article	
Michigan Oak	LA057LV2	
Modern Hickory	LA013 LA013C	
Natural Walnut	LA012 LA012C	
Noble Maple	LA002 LA002C	
Nordic Pine Modern	LA020 LA020C	
Nordic Pine Nature	LA019 LA019C	
Oak Champagne	LA051LV2	
Oak Grey	LA026M LA026MC	
Oak Wave Cream	LA059LV2	
Ocean Beech	LA025M LA025MC	
Ocean Oak	LA079MV2	
Ontario Oak	LA053LV2	
Oxford Oak	LA040M LA040MC	
Pepper Oak	LA060LV2	
Pino Delave	LA062XLV4	
Portuguese Oak	LA058LV2	
Tirol Oak Cream	LA043SV4 LA043LV2 LA043XLV4 LA043MV2	
Tirol Oak Grey	LA041SV4 LA041LV2 LA041XLV4 LA041MV2	
Tirol Oak Honey	LA044SV4 LA044LV2 LA044XLV4	
Tirol Oak Nature	LA042SV4 LA042LV2 LA042XLV4	
Tirol Oak Silver	LA045SV4 LA045LV2 LA045XLV4 LA045MV2	
Tirol Oak White	LA046SV4 LA046LV2 LA046XLV4 LA046MV2	
Traditional Oak Brown	LA024M LA024MC LA024SV4 LA024XLV4 LA024MV2	
Traditional Oak Grey	LA048SV4	
Virginia Oak	LA061LV2 LA061MV2	
Walnut Classic	LA034M LA034MC	
Washed Oak	LA050LV2 LA050MV2	















	18,5 / 38,5	14,5 / 50	19 / 58	15 / 70	15 / 80	18 / 115
Art. No.	30030356			30040408		
Art. No.	30030378			30040430		
Art. No.	30030377			30040429		
Art. No.	30030367			30040419		
Art. No.	30030385			30040437		
Art. No.	30030384			30040436		
Art. No.	30030350			30040402		
Art. No.	30030324			30040376		
Art. No.	30030358			30040410		
Art. No.	30030323			30040375		
Art. No.	30030386			30040438		
Art. No.	30030370			30040422		
Art. No.	30030338			30040390		
Art. No.	30030359			30040411		
Art. No.	30030361			30040413		
Art. No.	30030357			30040409		
Art. No.	30030386			30040438		
Art. No.	30030340			30040392		
Art. No.	30030343			30040395		
Art. No.	30030341			30040393		
Art. No.	30030344			30040396		
Art. No.	30030345			30040397		
Art. No.	30030322			30040374		
Art. No.	30030347			30040399		
Art. No.	30030360			30040412		
Art. No.	30030332			30040384		
Art. No.	30030353			30040405		



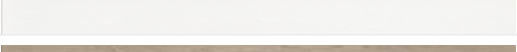

FUSSLEISTEN

SKIRTING BOARDS | PLINTHES | ZÓCALOS

Design	fit to article	
Welsh Dark Oak	LA009 LA009C LA009SV4	
Welsh Pale Oak	LA008 LA008C LA008SV4	
White Desire	LA037M LA037MC	
White Oak	LA007 LA007C	
Yale Oak	LA039M LA039MC	

ROCK'N'GO

Born to be wild	LA151SYS	
Dancing in the Dark	LA149SYSV4	
Here comes the sun	LA145SYSV4	
Hotel California	LA144SYSV4	
House of the rising sun	LA143SYSV4	
I was made for loving you	LA147SYSV4	
Knocking on heavens door	LA148SYSV4	
London Calling	LA150SYSV4	
Man on the Moon	LA142SYSV4	
Paint it Black	LA153SYS	
Under Pressure	LA152SYS	
Whiskey in the Jar	LA146SYSV4	

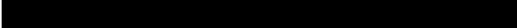
Uni-Design	fit to all articles	
Stainless steel polishes		
Stainless stell brushed		
Dark grey		
Light grey		
White		
Black		



	18,5 / 38,5	14,5 / 50	19 / 58	15 / 70	15 / 80	18 / 115
Art. No.	30030333			30040385		
Art. No.	30030373			30040425		
Art. No.	30030335			30040387		
Art. No.	30030372			30040424		
Art. No.	30030337			30040389		
Art. No.				30040448		
Art. No.				30040440		
Art. No.				30040444		
Art. No.				30040443		
Art. No.				30040442		
Art. No.				30040446		
Art. No.				30040439		
Art. No.				30040447		
Art. No.				30040441		
Art. No.				30040450		
Art. No.				30040449		
Art. No.				30040445		

	18,5 / 38,5	14,5 / 50	19 / 58	15 / 70	15 / 80	18 / 115
Art. No.					30060506	
Art. No.					30060505	
Art. No.		30060434				30011503
Art. No.		30060433				30011502
Art. No.	30030387	30060432	30060435	30040439	30060504	30011500
Art. No.				30040440		30011501

UNTERLAGSMATERIAL

UNDERLAY MATERIAL | SOUS-COUCHE | MATERIAL BASE

	silentPREMIUM (selbstklebend*)	silentCOMFORT	Sound-Protect Eco SD	Sound-Protect Eco Profi SD	Sound-Protect Eco
Art.	10020218	UCT1000	10020220	10020221	10020222
Material	Dauerelastisches Unterlagsmaterial aus bis zu 90 % natürlichen Rohstoffen Permanently elastic underlay material made of up to 90 % natural raw materials Sous-couche à élasticité permanente à base de près de 90 % de matières premières naturelles Material de soporte permanentemente elástico hecho hasta de un 90 % de materias primas naturales				
Materialdicke Thickness Épaisseur Grosor	1,8 mm	1,5 mm	2 mm	3 mm	2 mm
Gewicht ca. Weight Poids Peso	2,6 kg/m ²	1,5 kg/m ²	1,7 kg/m ²	2,8 kg/m ²	1,7 kg/m ²
Druckfestigkeit Compressive strength résistance à la compression resistencia a la presión	★★★★★	★★★★★	★★★★★	★★★★★	★★★★★
Wärmedurchlasswiderstand (Eignung Fußbodenheizung) thermal resistance (suitability for underfloor heating) conductivité thermique (Compatible sols chauffants) resistencia de penetración térmica en (idoneidad para calefacciones de suelo)	★★★★★	★★★★★	★★★★★	★★★★★	★★★★★
Resteindruck residual indentation poinçonnement rémanent huella residual	★★★★★	★★★★★	n.r.	n.r.	n.r.
Gehschallemission reflected walking sound émission des bruits de resonance emisión acústica de pasos	n.r.	n.r.	★★★★	★★★★	★★★★
Trittschallreduzierung impact sound reduction atténuation des bruits de pas reducción acústica de las pisadas	★★★	★★★	★★★★	★★★★	★★★★
Ausgleich von Unebenheiten uneven surface compensation compensation des inégalités compensación de irregularidades	★★	★★	★★★	★★★★	★★★
Lebensdauer lifetime durée de vie duración de vida	★★★★★				
Feuchteschutz (integr. Dampfbremse) humidity protection protection contre humidité protección contra humedad	n.r.	n.r.	✓	✓	✗
Eignung Suitability Aptitude Idoneidad	winea 1000				
	für NK** ≤ 32				
	Kleben to glue coller encolar	Klicken to click clic encajar	mineralischer Untergrund mineral ground support minéral superficie minerales		nicht-mineralischer Untergrund non-mineral ground aucun support minéral ningún superficie minerales

1 ★ = gut | good | bon | bien

5 ★★★★★ = sehr gut | very good | tres bien | excelente

n.r. = nicht relevant | not relevant | pas pertinent | irrelevante

✓ = ja | yes | oui | sí

✗ = nein | no | non | no

* self-adhesive | autoadhésif | autoadhesiva

** NK = Nutzungsklasse | Utilisation class | Classe d'usage | Clase de uso

■ PURLINE BIOBODEN | PURLINE ORGANIC FLOORING | PURLINE SOL ORGANIQUE | PURLINE SUELO BIO

■ DESIGNBODEN | DESIGN FLOORING | SOL DESIGN | SUELO DE DISEÑO

■ LAMINATBODEN | LAMINATE FLOORING | SOL STRATIFIÉ | SUELO LAMINADO

Sound-Protect Eco Profi	Noise-Protect SD	Noise-Protect Profi SD	Noise-Protect	Noise-Reduct	Noise-Reduct SD	Dämmplatte
10020223	10020226	10020227	10020228	10020225	10020230	10020229
	PE-Unterlagsschaum PE underlay foam mousse de base PE espuma base de PE			XPS-Unterlagsschaum XPS underlay foam mousse de base XPS espuma base de XPS		Holzfasерplatte fibreboard panneau de fibre fibra de madera
3 mm	2,5 mm	2,2 mm	2 mm	2 mm	2 mm	5 mm
2,8 kg/m ²	0,21 kg/m ²	0,32 kg/m ²	0,20 kg/m ²	0,09 kg/m ²	0,09 kg/m ²	1,65 kg/m ²
★★★★★	★	★★	★★	★★★	★★★	★★★★★
★★★★★	★★★	★★★★	★★★★	★	★	✗
n.r.	n.r.	n.r.	n.r.	n.r.	n.r.	n.r.
★★★★	★	★★★	★★★	★★	★★	★
★★★★	★★★★	★★★★	★★★★	★★★★	★★★★	★★★★★
★★★★	★★★★	★★★★	★★★★	★★★	★★★	★★★★★
	★	★★	★★	★★★★		★★★★★
✗	✓	✓	✗	✗	✓	✗

nicht-mineralischer
Untergrund
non-mineral ground
aucun support
minéral | ningún
superficie minerales

mineralischer Untergrund
mineral ground | support minéral
superficie minerales

nicht-mineralischer Untergrund
non-mineral ground | aucun support
minéral | ningún superficie minerales

mineralischer
Untergrund
mineral ground
support minéral
superficie minerales

nicht-mineralischer
Untergrund
non-mineral ground
aucun support
minéral | ningún
superficie minerales



Cradle to Cradle Certified™
is a certification mark
licensed exclusively for the
Cradle to Cradle Products
Innovation Institute



UNTERLAGSMATERIAL

UNDERLAY MATERIAL | SOUS-COUCHE | MATERIAL BASE

wineo silentPREMIUM

selbstklebend | self-adhesive | autocollante | autoadhesiva

- Dauerelastisches Unterlagsmaterial aus bis zu 90 % natürlichen Rohstoffen | Permanently elastic underlay material made of up to 90 % natural raw materials | Sous-couche à élasticité permanente à base de près de 90 % de matières premières naturelles | Material de soporte permanentemente elástico hecho hasta de un 90 % de materias primas naturales
- Dauerhaft hervorragende Trittschalleigenschaften | Permanently outstanding impact sound properties | Excellente durabilité des propriétés de réduction des bruits de résonance et de pas | Propiedades de reducción acústica de las pisadas
- Überbrückung von Untergrundunebenheiten | Bridges uneven patches in the subfloor | Corrige les inégalités de support | corrección de las irregularidades del suelo
- Erhöhung des Verlegekomforts | Increases installation ease and comfort | Augmente le confort de pose | Aumento de la comodidad de instalación
- Optimal geeignet für Fußbodenheizung | Most suitable for underfloor heating | Convient parfaitement au chauffage par le sol | Especialmente adecuada para suelos radiantes
- Geeignet für PURLINE Bioboden und wineo Designboden zum Kleben | Suitable for PURLINE organic flooring and wineo design flooring to glue | Parfaitement adapté à la mise en œuvre du PURLINE Sol Organique et aux sols design wineo à coller | Adecuada para PURLINE suelo bio y suelo de diseño wineo para encolar
- Dank selbstklebender Oberfläche kein zusätzlicher Klebstoff erforderlich | No additional adhesive necessary due to the self-adhesive surface | Grâce à sa surface autocollante, pas besoin de colle | Gracias a la superficie autoadhesiva, no es necesario ningún adhesivo adicional
- Bis Nutzungsklassen 23 und 32 | Up to utilisation classes 23 and 32 | Jusqu'aux classes d'usage 23 et 32 | Hasta las clases de utilización 23 y 32



www.blauer-engel.de/uz156

silentPREMIUM

Art. no. 10020218

Box = 40 Rollen/Palette | rolls/pallet | rouleaux/palette | rollos/palé | 6,5m²/Rolle | roll | rouleau | rollo

1,8mm Stärke | thickness | épaisseur/grosor | 1 m Breite | width | largeur | ancho

6,5m Länge | length | longueur | largo | 2,6kg/m² Gewicht | weight | poids | peso

13dB wineo PURLINE BIOBODEN | PURLINE ORGANIC FLOORING |
PURLINE SOL ORGANIQUE | PURLINE SUELO BIO

15dB wineo DESIGNBODEN | DESIGN FLOORING | SOL DESIGN | SUELO DE DISEÑO

0,01 (m²K)/W Wärmedurchlasswiderstand | thermal resistance | conductivité thermique | resistencia de penetración térmica

wineo silentCOMFORT

- Dauerelastisches Unterlagsmaterial aus bis zu 90 % natürlichen Rohstoffen | Permanently elastic underlay material made of up to 90 % natural raw materials | Sous-couche à élasticité permanente à base de près de 90 % de matières premières naturelles | Material de soporte permanentemente elástico hecho hasta de un 90 % de materias primas naturales
- Dauerhaft hervorragende Trittschalleigenschaften | Permanently outstanding impact sound properties | Excellente durabilité des propriétés de réduction des bruits de résonance et de pas | Propiedades de reducción acústica de las pisadas
- Überbrückung von Untergrundunebenheiten | Bridges uneven patches in the subfloor | Corrige les inégalités de support | corrección de las irregularidades del suelo
- Erhöhung des Verlegekomforts | Increases installation comfort | Augmente le confort de pose | Aumento de la comodidad de instalación
- Optimal geeignet für Fußbodenheizung | Most suitable for underfloor heating | Convient parfaitement au chauffage par le sol | Especialmente adecuada para suelos radiantes
- Geeignet für PURLINE Bioboden und wineo Designboden zum Klicken | Suitable for PURLINE organic flooring and wineo design flooring for clicking in | Parfaitement adapté à la mise en œuvre du PURLINE Sol Organique et aux sols design wineo à cliquer | Adecuada para PURLINE suelo bio y suelo de diseño wineo para encajar
- Erhöhung des Antirutscheffektes | Improvement non-slip effect | Amélioration de l'effet antidérapant | remedio de efecto antideslizante



www.blauer-engel.de/uz156

silentCOMFORT

Art. no. UCT1000

Box = 40 Rollen/Palette | rolls/pallet | rouleaux/palette | rollos/palé | 10m²/Rolle | roll | rouleau | rollo

1,5mm Stärke | thickness | épaisseur/grosor | 1 m Breite | width | largeur | ancho

10m Länge | length | longueur | largo | 1,5kg/m² Gewicht | weight | poids | peso

14dB wineo PURLINE BIOBODEN | PURLINE ORGANIC FLOORING |
PURLINE SOL ORGANIQUE | PURLINE SUELO BIO

14dB wineo DESIGNBODEN | DESIGN FLOORING | SOL DESIGN | SUELO DE DISEÑO

0,01 (m²K)/W Wärmedurchlasswiderstand | thermal resistance/ conductivité thermique | resistencia de penetración térmica

UNTERLAGSMATERIAL

UNDERLAY MATERIAL | SOUS-COUCHE | MATERIAL BASE

wineo Sound-Protect Eco

mit integrierter Dampfbremse | with integrated vapour barrier | avec pare-vapeur PE intégré | con barrera de vapor integrada

- Dauerelastisches Unterlagsmaterial aus bis zu 90 % natürlichen Rohstoffen | Permanently elastic underlay material made of up to 90 % natural raw materials | Sous-couche à élasticité permanente à base de près de 90 % de matières premières naturelles | Material de soporte permanentemente elástico hecho hasta de un 90 % de materias primas naturales
- Dauerhaft hervorragende Geh- und Trittschalleigenschaften | Permanently outstanding impact sound properties | Excellente durabilité des propriétés de réduction des bruits de résonance et de pas | Propiedades de reducción acústica de las pisadas
- Optimal geeignet für Fußbodenheizung | Most suitable for underfloor heating | Convient parfaitement au chauffage par le sol | Especialmente adecuada para suelos radiantes
- Geeignet für alle mineralischen Untergründe | Suitable for all mineral sub floors | Compatible sur tout support minéral | Adecuada para todas superficies minerales
- Integrierte Dampfbremse bei Verkleben der Stoßkanten mit Combi-Dichtband | Integrated vapour barrier when adhering the seams with combi sealing tape | Pare-vapeur intégré en cas de collage des rebords avec bande d'étanchéité combinée | Barrera de vapor integrada al encolar el borde con cinta selladora combi



www.blauer-engel.de/uz156

Sound-Protect Eco Profi SD

Art. no. 10020221

Box = 40 Rollen/Palette | rolls/pallet | rouleaux/palette | rollos/palé | 5,5m²/Rolle | roll | rouleau | rollo
3mm Stärke | thickness | épaisseur | grosor | 1m Breite | width | largeur | ancho
5,5m Länge | length | longueur | largo | 2,8kg/m² Gewicht | weight | poids | peso

~ 20dB | ca. 31 % Gehschallemission | reflected walking sound | émission des bruits de resonance
emisión acústica de pasos

0,01 (m²K)/W Wärmedurchlasswiderstand | thermal resistance | conductivité thermique | resistencia
de penetración térmica

SD-Wert: ≥ 75m

Sound-Protect Eco SD

Art. no. 10020220

Box = 40 Rollen/Palette | rolls/pallet | rouleaux/palette | rollos/palé | 8m²/Rolle | roll | rouleau | rollo

2mm Stärke | thickness | épaisseur | grosor | 1m Breite | width | largeur | ancho
8m Länge | length | longueur | largo | 1,7kg/m² Gewicht | weight | poids | peso

~ 19dB | ca. 28 % Gehschallemission | reflected walking sound | émission des bruits de
resonance | emisión acústica de pasos

0,01 (m²K)/W Wärmedurchlasswiderstand | thermal resistance | conductivité thermique | resistencia
de penetración térmica

SD-Wert: ≥ 75m

wineo Sound-Protect Eco

- Dauerelastisches Unterlagsmaterial aus bis zu 90 % natürlichen Rohstoffen | Permanently elastic underlay material made of up to 90 % natural raw materials | Sous-couche à élasticité permanente à base de près de 90 % de matières premières naturelles | Material de soporte permanentemente elástico hecho hasta de un 90 % de materias primas naturales
- Dauerhaft hervorragende Geh- und Trittschalleigenschaften | Permanently outstanding impact sound properties | Excellente durabilité des propriétés de réduction des bruits de résonance et de pas | Propiedades de reducción acústica de las pisadas
- Optimal geeignet für Fußbodenheizung | Most suitable for underfloor heating | Convient parfaitement au chauffage par le sol | Especialmente adecuada para suelos radiantes
- Geeignet für alle nicht-mineralischen Untergründe | Suitable for all non-mineral sub floors | Compatible sur tout support non minéral | Adecuada para todas superficies no minerales (für mineralische Untergründe nur in Verbindung mit Dampfbremse) | (for mineral sub floors in conjunction with vapour barrier only) | (mise en œuvre sur support minéral uniquement en combinaison avec un pare-vapeur) | (para los subsuelos minerales en combinación con barrera de vapor)



www.blauer-engel.de/uz156

Sound-Protect Eco Profi

Art. no. 10020223

Box = 40 Rollen/Palette | rolls/pallet | rouleaux/palette | rollos/palé | 5,5m²/Rolle | roll | rouleau | rollo

3mm Stärke | thickness | épaisseur | grosor | 1 m Breite | width | largeur | ancho

5,5m Länge | length | longueur | largo | 2,8 kg/m² Gewicht | weight | poids | peso

~ 20dB | ca. 31 % Gehschallemission | reflected walking sound | émission des bruits de resonance
emisión acústica de pasos

0,01 (m²K)/W Wärmedurchlasswiderstand | thermal resistance | conductivité thermique | resistencia
de penetración térmica

Sound-Protect Eco

Art. no. 10020222

Box = 40 Rollen/Palette | rolls/pallet | rouleaux/palette | rollos/palé | 8 m²/Rolle | roll | rouleau | rollo

2mm Stärke | thickness | épaisseur | grosor | 1 m Breite | width | largeur | ancho

8m Länge | length | longueur | largo | 1,7 kg/m² Gewicht | weight | poids | peso

~ 19dB | ca. 28 % Gehschallemission | reflected walking sound | émission des bruits de
resonance | emisión acústica de pasos

0,01 (m²K)/W Wärmedurchlasswiderstand | thermal resistance | conductivité thermique | resistencia
de penetración térmica

wineo Noise-Protect

mit integrierter Dampfbremse | with integrated vapour barrier | avec pare-vapeur PE intégré | con barrera de vapor integrada

- PE-Unterlagsschaum | PE underlay foam | mousse de base PE | espuma base de PE
- Gute Geh- und Trittschalleigenschaften | good impact sound properties | Bonne durabilité des propriétés de réduction des bruits de résonance | Propiedades de reducción acústica de las
- Optimal geeignet für Fußbodenheizung | Most suitable for underfloor heating | Convient parfaitement au chauffage par le sol | Especialmente adecuada para suelos radiantes
- Geeignet für alle mineralischen Untergründe | Suitable for all mineral sub floors | Compatible sur tout support minéral | Adecuada para todas superficies minerales
- Integrierte Dampfbremse inkl. überlappender Verklebung | Integrated vapour barrier inclusive overlapping adhesive | Pare-vapeur intégré inclus le collage en chevauchement | Barrera de vapor integrada incluido el pegado de solapamiento

Noise-Protect Profi SD

Art. no. 10020227

Box = 20 Rollen/Palette | rolls/pallet | rouleaux/palette | rollos/palé | 15m²/Rolle | roll | rouleau | rollo

2,2mm Stärke | thickness | épaisseur | grosor | 1 m Breite | width | largeur | ancho

15m Länge | length | longueur | largo | 0,26 kg/m² Gewicht | weight | poids | peso

~ 19dB | 15% Gehschallemission | reflected walking sound | émission des bruits de resonance | emisión acústica de pasos | SD-Wert: ≥ 75m

Noise-Protect SD

Art. no. 10020226

Box = 2 Rollen/Sack | rolls/bag | rouleaux/sac | rollos/saco | 30m²/Rolle | roll | rouleau | rollo

2,5mm Stärke | thickness | épaisseur | grosor | 1 m Breite | width | largeur | ancho

30m Länge | length | longueur | largo | 0,13 kg/m² Gewicht | weight | poids | peso

~ 19dB | 7% Gehschallemission | reflected walking sound | émission des bruits de resonance | emisión acústica de pasos | SD-Wert: ≥ 75m

wineo Noise-Protect

- PE-Unterlagsschaum | PE underlay foam | mousse de base PE | espuma base de PE
- Gute Geh- und Trittschalleigenschaften | good impact sound properties | bon durabilité des propriétés de réduction
- Optimal geeignet für Fußbodenheizung | Most suitable for underfloor heating | Convient parfaitement au chauffage par le sol | Especialmente adecuada para suelos radiantes
- Geeignet für alle nicht-mineralischen Untergründe | Suitable for all non- mineral sub floors | Compatible sur tout support non minéral | Adecuada para todas superficies no minerales (für mineralische Untergründe nur in Verbindung mit Dampfbremse) | (for mineral sub floors in conjunction with vapour barrier only) | (pour les supports minéraux uniquement en combinaison avec un pare-vapeur) | (para los subsuelos minerales en combinación con barrera de vapor)

Noise-Protect Profi

Art. no. 10020228

Box = 6 Rollen/Karton | rolls/cardboard | rouleaux/carton | rollos/cartón | 15m²/Rolle | roll | rouleau | rollo

2mm Stärke | thickness | épaisseur | grosor | 1 m Breite | width | largeur | ancho

15m Länge | length | longueur | largo | 0,26 kg/m² Gewicht | weight | poids | peso

~ 19dB | 15% Gehschallemission | reflected walking sound | émission des bruits de resonance | emisión acústica de pasos

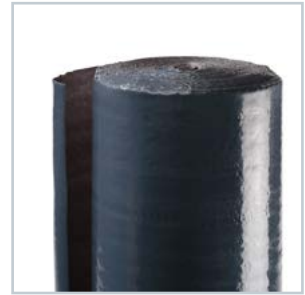

wineo Noise-Reduct

mit integrierter Dampfbremse | with integrated vapour barrier | avec pare-vapeur PE intégré | con barrera de vapor integrada

- XPS-Unterlagsschaum mit guter Wärmedämmung | XPS underlay foam with good heat insulation | Mousse de base XPS avec bonne isolation thermique | Espuma base de XPS con buen aislamiento térmico
- Sehr gute Trittschalleigenschaften | Very good impact sound properties | Très bonne durabilité des propriétés de réduction des bruits de résonance | Propiedades de reducción acústica de las pisadas muy bien
- Nicht geeignet für Fußbodenheizung | Not suitable for underfloor heating | Ne convient pas au chauffage par le sol | No adecuada para suelos radiantes
- Geeignet für alle mineralischen Untergründe | Suitable for all mineral sub floors | Compatible sur tout support minéral | Adecuada para todos superficies minerales
- Integrierte Dampfbremse inkl. überlappender Verklebung | Integrated vapour barrier inclusive overlapping adhesive | Pare-vapeur intégré inclus le collage en chevauchement | Barrera de vapor integrada incluido el pegado de solapamiento



Noise-Reduct SD

Art. no. 10020230

Box = 48 Rollen/Palette | rolls/pallet | rouleaux/palette | rollos/palé | 15 m²/Rolle | roll | rouleau | rollo

2mm Stärke | thickness | épaisseur | grosor | 1 m Breite | width | largeur | ancho

15m Länge | length | longueur | largo | 0,08 kg/m² Gewicht | weight | poids | peso

~ 20 dB | 12 % Gehschallemission | reflected walking sound | émission des bruits de resonance
emisión acústica de pasos

SD-Wert: ≥ 75 m

wineo Noise-Reduct

- XPS-Unterlagsschaum mit guter Wärmedämmung | XPS underlay foam with good heat insulation | Mousse de base XPS avec bonne isolation thermique | Espuma base de XPS con buen aislamiento térmico
- Sehr gute Trittschalleigenschaften | Very good impact sound properties | Très bonne durabilité des propriétés de réduction des bruits de résonance | Propiedades de reducción acústica de las pisadas muy bien
- Nicht geeignet für Fußbodenheizung | Not suitable for underfloor heating | Ne convient pas au chauffage par le sol | No adecuada para suelos radiantes
- Geeignet für alle nicht-mineralischen Untergründe | Suitable for all non-mineral sub floors | Compatible sur tout support non minéral | Adecuada para todos superficies no minerales (für mineralische Untergründe nur in Verbindung mit Dampfbremse) | (for mineral sub floors in conjunction with vapour barrier only) | (pour les supports minéraux uniquement en combinaison avec un pare-vapeur) | (para los subsuelos minerales en combinación con barrera de vapor)



Noise-Reduct

Art. no. 10020225

Box = 48 Rollen/Palette | rolls/pallet | rouleaux/palette | rollos/palé | 16,5 m²/Rolle | roll | rouleau | rollo

2mm Stärke | thickness | épaisseur | grosor | 1,1 m Breite | width | largeur | ancho

15m Länge | length | longueur | largo | 0,08 kg/m² Gewicht | weight | poids | peso

~ 20 dB | 12 % Gehschallemission | reflected walking sound | émission des bruits de resonance
emisión acústica de pasos

wineo Dämmplatte | wineo insulation board | Panneau isolant de wineo | Placa aislante wineo

- Holzfaserplatte mit guter Wärmedämmung | Fibreboard panel with good heat insulation
Panneau de fibres avec bonne isolation thermique | Paneles de fibras de madera con buen aislamiento térmico
- Dauerhaft hervorragende Trittschalleigenschaften | Permanently outstanding impact sound properties | Excellente durabilité des propriétés de réduction des bruits de résonance et de pas | Propiedades de reducción acústica de las pisadas
- Ermöglicht einen Höhenausgleich bis ca. 3 mm | Enables a height adjustment up to approx. 3 mm/Permet un ajustement en hauteur jusqu'à env. 3 mm | Permite un ajuste de altura de hasta 3 mm
- Nicht geeignet für Fußbodenheizung | Not suitable for underfloor heating | Ne convient pas au chauffage par le sol | No adecuada para suelos radiantes
- Geeignet für alle nicht-mineralischen Untergründe | Suitable for all non-mineral sub floors
Compatible sur tout support non minéral | Adecuada para todas superficies no minerales (für mineralische Untergründe nur in Verbindung mit Dampfbremse) | (for mineral sub floors in conjunction with vapour barrier only) | (pour les supports minéraux uniquement en combinaison avec un pare-vapeur) | (para los subsuelos minerales en combinación con barrera de vapor)

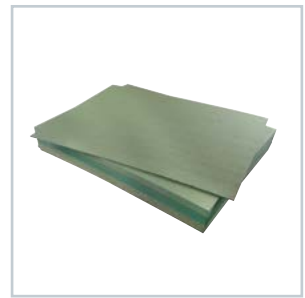

Dämmplatte | insulation board | Panneau isolant de | Placa aislante

Art. no. 10020229

Box = 24 Pakete/Palette | boxes/pallet | paquets/palette | cajas/palé | 1 Paket/7 m² (15 Stück | 15 pieces | 15 unités | 15 piezas)

5 mm Stärke | thickness | épaisseur | grosor | 0,59 m Breite | width | largeur | ancho
0,79 m Länge | length | longueur | largo | 1,65 kg/m² Gewicht | weight | poids | peso

~ 22 dB | 11 % Gehschallemission | reflected walking sound | émission des bruits de resonance | emisión acústica de pasos

wineo PE-Dampfbremse | PE vapour barrier | PE Pare-vapeur PE Barrera de vapor

- Dünne PE-Folie für den Einsatz unter allen Hartbodenbelägen (nicht erforderlich bei Holzuntergründen) | Thin PE film for use underneath all resilient floor coverings (not necessary with wooden subfloors) | Film PE fin pour une utilisation sous tous les revêtements de sol durs (non requis pour les supports en bois) | Lámina fina de PE para el uso bajo de todos los recubrimientos de suelo duros (no necesaria para en subsuelos de madera)
- Dient als Trennlage zwischen Estrich und Dämmunterlage | Acts as separation layer between screed and underlay material | Sert de couche de séparation entre la chape et la sous-couche isolante | Sirve de capa de separación entre el pavimento y la base de aislamiento
- B2 zertifiziert | B2 certified | Certification B2 | Certificación B2



PE-Dampfbremse | PE vapour barrier | PE Pare-vapeur PE Barrera de vapor

Art. no. 10100015

Box = 100 Rollen/Palette | rolls/pallet | rouleaux/palette | rollos/palé | 30 m²/Rolle | roll | rouleau | rollo

0,125 mm Stärke | thickness | épaisseur | grosor | 1 m Breite | width | largeur | ancho
30 m Länge | length | longueur | largo

wineo Combi-Dichtband | wineo combi sealing tape | Bande d'étanchéité combinée de wineo | Cinta selladora combi wineo

- Spezialklebeband zum Abdichten der Stoßkanten von Dämmunterlagen | Special adhesive tape for sealing the end edges of insulating underlays | Bande adhésive d'étanchéité, pour jonction des lés des sous couche | Cinta adhesiva especial para sellar los bordes de las bases de aislamiento
- Erforderlich zu allen Dämmmatten mit integrierter Dampfbremse | Required for all insulation mats with integrated vapour barrier | Requisite pour toutes les sous-couches inutile avec pare vapeur intégré à recouvrement | Necesarias para todas las estrillas aislantes con barrea de vapour integrada



Combi-Dichtband | combi sealing tape | Bande d'étanchéité combinée de Cinta selladora combi wineo Art. no. 100206022





Box = 1 Rolle | roll | rouleau | rollo

50 mm Breite | width | largeur | ancho | 50 m Länge | length | longueur | largo

AKZENTSTREIFEN | FEATURE STRIPS | JOINTS EFFET CARRELAGE | FRANJAS DECORATIVAS

Für eine Planken- oder Fliesenoptik mit Fugen-Effekt. | For a natural look of planks or tiles with joint effect.
Souligner l'aspect naturel des lames ou des dalles avec un effet joint décoratif | Subrayar un aspecto natural de tablas o de baldosas con un efecto de juntas.









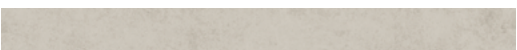
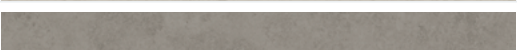
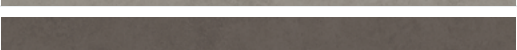

Breite width largeur ancho	5 mm
Stärke thickness épaisseur grosor	2 mm/2,5 mm
Länge length longueur largo	1000 mm
Box	50 m

Uni-Design	2 mm	2,5 mm	
Anthracite	AAN20DL	AAN25DL	
Cream	ACR20DL	ACR25DL	
Dark brown	ADB20DL	ADB25DL	
Black	ASW20DL	ASW25DL	
Silver grey	ASG20DL	ASG25DL	

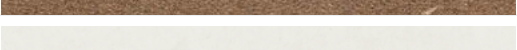
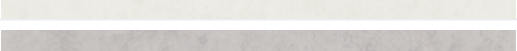
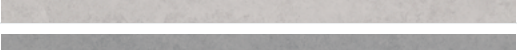
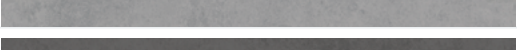
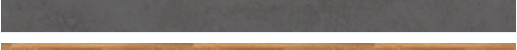
HOCHZÜGE, AUSSENECKEN & SCHMELZDRÄHTE

SKIRTING BOARDS, EXTERNAL CORNERS AND WELD RODS | REMONTÉES DE PLINTHES, ANGLES EXTÉRIEURS ET CORDONS DE SOUDURE | RODAPIÉS, ESQUINAS EXTERIORES Y CORDONES DE SOLDADURA





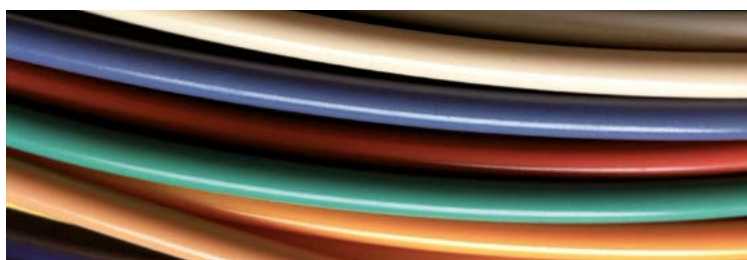



















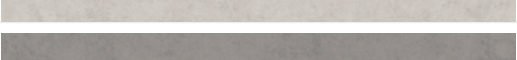
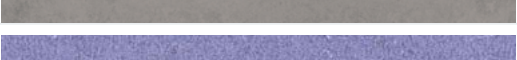



- Für den Einsatz im Health & Care Bereich | For use in Health & Care | Pour l'usage dans le secteur Health & Care
Para el uso en el área Health & Care
- Für saubere Wandabschlüsse, wo Hygiene notwendig ist | Ensure a proper wall finish where hygiene is essential
Assurent une finition murale nette où l'hygiène est essentielle | proporcionar un acabado a un pared limpio donde la higiene es esencial
- In jedem Design der Kollektion erhältlich | Available in every collection design | Dans tous les designs des collections disponible | En cada diseño de las colecciones disponible
- Schmelzdrähte sind dekorgleich erhältlich | Fusewires are available which are similar to the decor | Cordons de soudure sont disponible dans la couleur du décor | Cordones de soldadura estan disponible en el color de decorativo

Design	fit to article	
Apple Green	PLR185C	
Bright.One	PLR115C	
Bright.Two	PLR116C	
Bright.Three	PLR117C	
Bright.Four	PLR118C	
Cappuccino	PLR004C	
Cool.One	PLR107C	
Cool.Two	PLR108C	
Cool.Three	PLR109C	
Cool.Four	PLR110C	
Cottage Oak	PLR038C	
Denim Blue Stars	PLR132C	
Floating Wood Sand	PLR134C	
Floating Wood Snow	PLR133C	
Halifax Oak	PLR036C	
Honey Mustard	PLR128C	
Jungle Green	PLR018C	

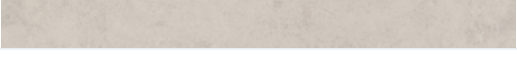

	Skirting Boards	External Corners	Weld rods
Height	100 mm	100 mm	4 mm
Depth	100 mm	100 mm	4 mm
Length	2400 mm	230 mm je Seite either les deux los dos	60 m/Rolle roll rouleau rollo
Box	10 Stück pieces unités piezas	10 Stück pieces unités piezas	1 Rolle roll rouleau rollo

	Hochzüge Skirting Boards Remontées de plinthes Rodapiés	Aussenecken External Corners Angles Extérieures Esquinas Exteriores	Schmelzdrähte Weld rods Cordons de Soudure Cordones de Soldadura
	PH185	PE185	PS185
	PH115	PE115	PS115
	PH116	PE116	PS116
	PH117	PE117	PS117
	PH118	PE118	PS118
	PH004	PE004	PS004
	PH107	PE107	PS107
	PH108	PE108	PS108
	PH109	PE109	PS109
	PH110	PE110	PS110
	PH038	PE038	PS038
	PH132	PE132	PS132
	PH134	PE134	PS134
	PH133	PE133	PS133
	PH036	PE036	PS036
	PH128	PE128	PS128
	PH018	PE018	PS018

Light Grey	PLR021C	
Melange	PLR003C	
Midnight Grey	PLR024C	
Midnight Grey Stars	PLR126C	
Missouri Oak	PLR039C	
Napa Walnut Brown	PLR136C	
Napa Walnut Cream	PLR135C	
Navi Blue	PLR129C	
Navi Blue Stars	PLR131C	
Pacific Oak	PLR037C	
Pure Black Stars	PLR127C	
Pure White	PLR025C	
Pure White Stars	PLR123C	
Pure.One	PLR111C	
Pure.Two	PLR112C	
Pure.Three	PLR113C	
Pure.Four	PLR114C	
Racing Green	PLR019C	
Red Rubin	PLR011C	
Silver Grey	PLR022C	
Silver Grey Stars	PLR124C	
Sinai Sand	PLR002C	
Sinai Sand Stars	PLR130C	
Steel Grey	PLR023C	
Summer Sky	PLR014C	
Terracotta Dark	PLR009C	
Warm.One	PLR119C	
Warm.Two	PLR120C	
Warm.Three	PLR121C	
Warm.Four	PLR122C	

PH021	PE021	PS021
PH003	PE003	PS003
PH024	PE024	PS024
PH126	PE126	PS126
PH039	PE039	PS039
PH136	PE136	PS136
PH135	PE135	PS135
PH129	PE129	PS129
PH131	PE131	PS131
PH037	PE037	PS037
PH127	PE127	PS127
PH025	PE025	PS025
PH123	PE123	PS123
PH111	PE111	PS111
PH112	PE112	PS112
PH113	PE113	PS113
PH114	PE114	PS114
PH019	PE019	PS019
PH011	PE011	PS011
PH022	PE022	PS022
PH124	PE124	PS124
PH002	PE002	PS002
PH130	PE130	PS130
PH023	PE023	PS023
PH014	PE014	PS014
PH009	PE009	PS009
PH119	PE119	PS119
PH120	PE120	PS120
PH121	PE121	PS121
PH122	PE122	PS122

ALUMINIUMPROFILE IN HOLZ- UND METALLOPTIK ALUMINIUM PROFILES IN WOOD AND METAL FINISH PROFILÉS ALUMINIUM ASPECT BOIS ET METAL PERFILES DE ALUMINIO EN OPTICA DE MADERA Y METAL

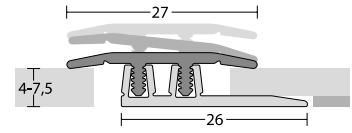

Übergangsprofil Profi-Design | Transition profile Profi-Design | Profilés de transition Profi-Design | Perfiles des transición Profi-Design

für Belagstärken von 4–7,5 mm, Breite 27 mm | for floor covering thicknesses of 4–7,5 mm, width 27 mm | pour des épaisseurs de revêtement de 4 à 7,5 mm, largeur 27 mm | para grosos de revestimiento de 4–7,5 mm, ancho 27 mm

Zweiteiliges Aluminiumprofil zur Überdeckung von Dehnungsfugen | Two-part aluminium profile for covering expansion joints | Profilé aluminium en deux parties pour recouvrir des joints de fractionnement | Perfil de aluminio de dos partes para recubrir las juntas de dilatación

Box = 10 Stück/Karton | pieces/box | unités/carton | piezas/cartón | Mindestbestellmenge | minimum order size | commande minimum | pedido mínimo = 1 Stück | pieces | unités | piezas

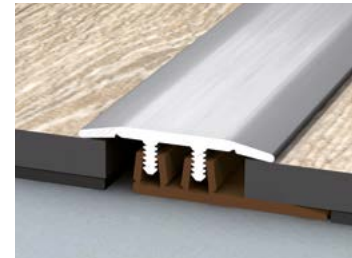

Uni-Design	1 m	2,7 m	
Stainless stell brushed	48100491	48100476	
Stainless steel matt	48100489	48100474	
Stainless stell polishes	48100490	48100475	
Sand	48100487	48100472	
Silver	48100488	48100473	

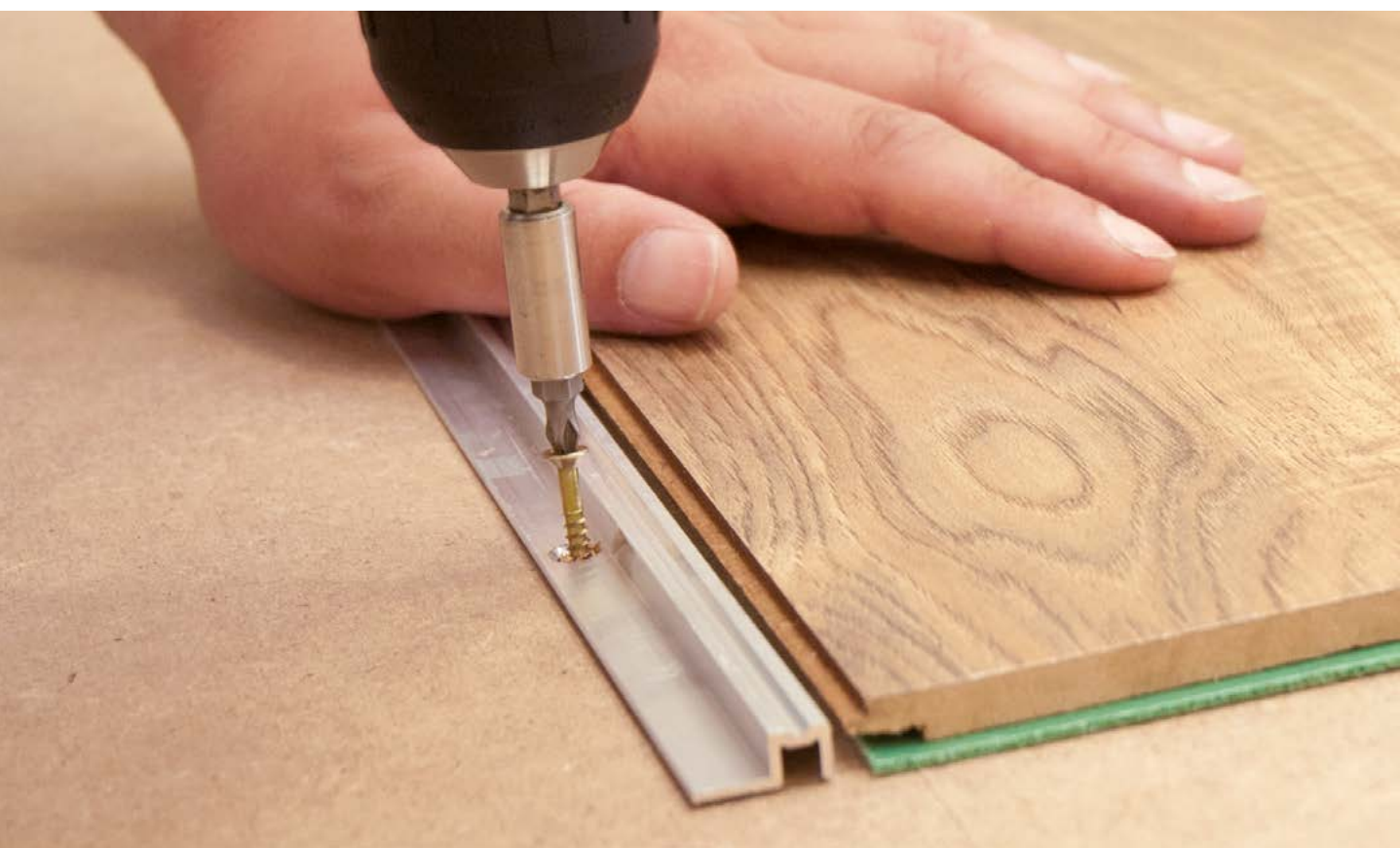







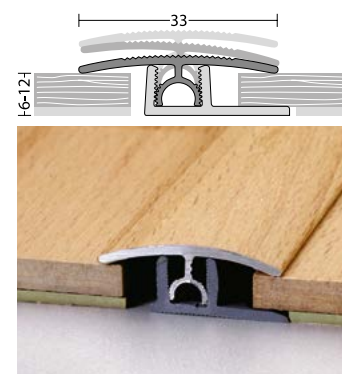

Übergangsprofil Profitec Junior | Transition profile Profitec Junior | Profilés de transition Profitec Junior | Perfiles des transición Profitec Junior

für Belagstärken von 6–12 mm, Breite 33 mm | for floor covering thicknesses of 6–12 mm, width 33 mm | pour des épaisseurs de revêtement de 6 à 12 mm, largeur 33 mm | para grosos de revestimiento de 6–12, ancho 33 mm

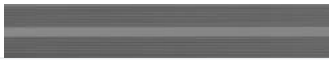
Zweiteiliges Aluminiumprofil zur Überdeckung von Dehnungsfugen | Two-part aluminium profile for covering expansion joints | Profilé aluminium en deux parties pour recouvrir des joints de fractionnement | Perfil de aluminio de dos partes para recubrir las juntas de dilatación

Box = 10 Stück/Karton | pieces/box | unités/carton | piezas/cartón | Mindestbestellmenge | minimum order size | commande minimum | pedido mínimo = 1 Stück | pieces | unités | piezas



Design	1 m	2,7 m	
Maple		48100429	
Beech		48100427	
Stainless steel matt	48100450	48100426	
Oak light		48100428	
Cherry		48100430	
Nutwood		48100431	
Silver	48100449	48100425	
Sand	48100448	48100424	

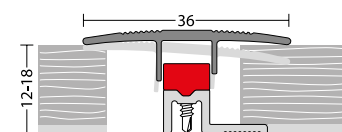
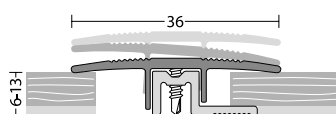



Übergangsprofil PS400PEP | Transition profile PS400PEP | Profilés de transition PS400PEP | Perfiles des transición PS400PEP

für Belagstärken von 6–13 mm, Breite 36 mm | for floor covering thicknesses of 6–13 mm, width 36 mm | pour des épaisseurs de revêtement de 6 à 13 mm, largeur 36 mm | para grosos de revestimiento de 6–13, ancho 36 mm

Geschraubtes zweiteiliges Aluminiumprofil zur Überdeckung von Dehnungsfugen | Bolted Two-part aluminium profile for covering expansion joints | Profile aluminium épaisseur en deux parties pour recouvrir des joints de fractionnement | Perfil de aluminio reapretado de dos partes para recubrir las juntas de dilatación

Box = 10 Stück/Karton | pieces/box | unités/carton | piezas/cartón | Mindestbestellmenge | minimum order size | commande minimum | pedido mínimo = 1 Stück | pieces | unités | piezas

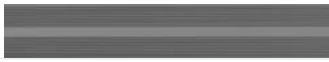
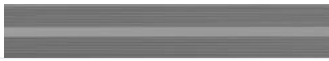

Uni-Design	1 m	2,7 m	Erhöhungsblock height adjustment block cale de réhausse bloque de elevación	
Stainless steel matt	48100414	48100402	48100502	
Stainless stell polishes	48100415	48100403	48100503	
Sand	48100412	48100400	48100502	
Silver	48100413	48100401	48100503	

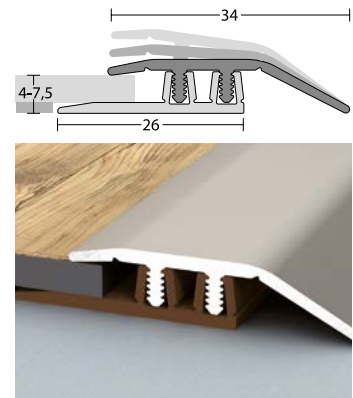





Anpassungsprofil Profi-Design | Adjustment profile Profi-Design | Profilés d'adaptation Profi-Design | Perfil de adaptación Profi-Design

für Belagstärken von 4–7,5 mm, Breite 34 mm | for floor covering thicknesses of 4–7,5 mm, width 34 mm | pour des épaisseurs de revêtement de 4 à 7,5 mm, largeur 34 mm | para grosos de revestimiento de 4–7,5 mm, ancho 34 mm

Zweiteiliges Aluminiumprofil für Übergänge zwischen unterschiedlich hohen Bodenbelägen | Two-part aluminium profile for transitions between floor coverings of different heights | Profilé aluminium en deux parties pour des transitions entre revêtements de hauteurs différentes | Perfil de aluminio de dos partes para pasos entre revestimientos con alturas diferentes

Box = 10 Stück/Karton | pieces/box | unités/carton | piezas/cartón | Mindestbestellmenge | minimum order size | commande minimum | pedido mínimo = 1 Stück | pieces | unités | piezas

Uni-Design	1 m	2,7 m	
Stainless steel brushed	48100496	48100481	
Stainless steel matt	48100494	48100479	
Stainless steel polishes	48100495	48100480	
Sand	48100492	48100477	
Silver	48100493	48100478	

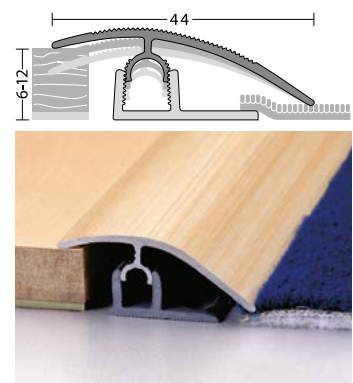







Anpassungsprofil Profitec Junior | Adjustment profile Profitec Junior | Profilés d'adaptation Profitec Junior | Perfil de adaptación Profitec Junior

für Belagstärken von 6–12 mm, Breite 44 mm | for floor covering thicknesses of 6–12 mm, width 44 mm | pour des épaisseurs de revêtement de 6 à 12 mm, largeur 44 mm | para grosos de revestimiento de 6–12 mm, ancho 44 mm

Zweiteiliges Aluminiumprofil für Übergänge zwischen unterschiedlich hohen Bodenbelägen | Two-part aluminium profile for transitions between floor coverings of different heights/ Profilé aluminium en deux parties pour des transitions entre revêtements de hauteurs différentes/ Perfil de aluminio de dos partes para pasos entre revestimientos con alturas diferentes

Box = 10 Stück/Karton | pieces/box | unités/carton | piezas/cartón | Mindestbestellmenge | minimum order size | commande minimum | pedido mínimo = 1 Stück | pieces | unités | piezas

Design	1 m	2,7 m	
Maple		48100437	
Beech		48100435	
Stainless steel matt	48100458	48100434	
Oak light		48100436	
Cherry		48100438	
Nutwood		48100439	
Sand	48100456	48100432	
Silver	48100457	48100433	

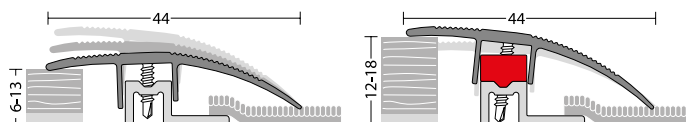

Anpassungsprofil PS400PEP | Adjustment profile PS400PEP | Profils d'adaptation PS400PEP | Perfil de adaptación PS400PEP

für Belagstärken von 6–13 mm, Breite 44 mm | for floor covering thicknesses of 6–13 mm, width 44 mm | pour des épaisseurs de revêtement de 6 à 13 mm, largeur 44 mm | para grosos de revestimiento de 6–13, ancho 44 mm

Geschraubtes, zweiteiliges Aluminiumprofil für Übergänge zwischen unterschiedlich hohen Bodenbelägen | Bolted two-part aluminium profile for covering of different heights | Profile aluminium vissé en deux parties pour des transitions entre revêtements de hauteurs différentes | Perfil de aluminio reapretado de dos partes para pasos entre revestimientos con alturas diferentes

Box = 10 Stück/Karton | pieces/box | unités/carton | piezas/cartón | Mindestbestellmenge | minimum order size
commande minimum | pedido mínimo = 1 Stück | pieces | unités | piezas



Uni-Design	1 m	2,7 m	Erhöhungsblock height adjustment block cale de réhausse bloque de elevación
Stainless steel matt	48100418	48100406	48100502
Stainless steel polishes	48100419	48100407	48100503
Sand	48100416	48100404	48100502
Silver	48100417	48100405	48100503

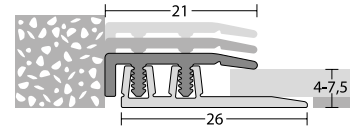





Abschlussprofil Profi-Design | End profile Profi-Design | Profilé de finition Profi-Design | Perfil de acabado Profi-Design

für Belagstärken von 4–7,5 mm, Breite 21 mm | for floor covering thicknesses of 4-7,5 mm, width 21 mm | pour des épaisseurs de revêtement de 4 à 7,5 mm, largeur 21 mm | para grosos de revestimiento de 4–7,5 mm, ancho 21 mm

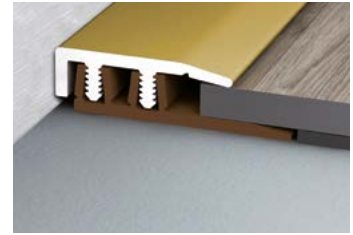
Zweiteiliges Aluminiumprofil, z. B. für Wandabschlüsse | Two-part aluminium profile for wall endings | Profilé aluminium en deux parties, par ex. pour finitions murales | Perfil de aluminio de dos partes, por ejemplo para acabados de pared

Box = 10 Stück/Karton | pieces/box | unités/carton | piezas/cartón | Mindestbestellmenge | minimum order size | commande minimum | pedido mínimo = 1 Stück | pieces | unités | piezas



Uni-Design	1 m	2,7 m	
Stainless steel brushed	48100501	48100486	
Stainless steel matt	48100499	48100484	
Stainless steel polishes	48100500	48100485	
Sand	48100497	48100482	
Silver	48100498	48100483	

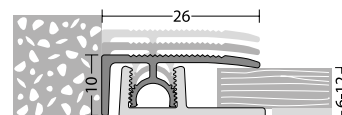

Abschlussprofil Profitec Junior | End profile Profitec Junior | Profilé de finition Profitec Junior | Perfil de acabado Profitec Junior

für Belagstärken von 6–12 mm, Breite 26 mm | for floor covering thicknesses of 6–12mm, width 26 mm | pour des épaisseurs de revêtement de 6 à 12 mm, largeur 26 mm | para grosos de revestimiento de 6–12 mm, ancho 26 mm

Zweiteiliges Aluminiumprofil, z. B. für Wandabschlüsse | Two-part aluminium profile for wall endings | Profilé aluminium en deux parties, par ex. pour finitions murales | Perfil de aluminio de dos partes, por ejemplo para acabados de pared

Box = 10 Stück/Karton | pieces/box | unités/carton | piezas/cartón | Mindestbestellmenge | minimum order size | commande minimum | pedido mínimo = 1 Stück | pieces | unités | piezas



Design	1 m	2,7 m	
Maple	48100469	48100445	
Beech	48100467	48100443	
Stainless steel matt	48100466	48100442	
Light Oak	48100468	48100444	
Cherry	48100470	48100446	
Nutwood	48100471	48100447	
Sand	48100464	48100440	
Silver	48100465	48100441	

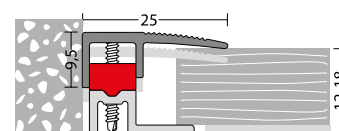
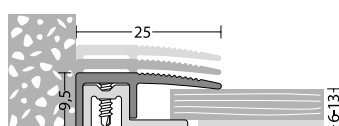

Abschlussprofil PS400PEP | End profile PS400PEP | Profilé de finition PS400PEP | Perfil de acabado PS400PEP

für Belagstärken von 6–13 mm, Breite 25 mm | for floor covering thicknesses of 6–13mm, width 25 mm | pour des épaisseurs de revêtement de 6 à 13 mm, largeur 25 mm | para grosos de revestimiento de 6–13 mm, ancho 25 mm

Geschraubtes, zweiteiliges Aluminiumprofil, z.B. für Wandabschlüsse | Bolted two-part aluminium profile for transitions between floor coverings of different heights | Profilé aluminium visse en deux parties par ex. pour finitions murales de hauteurs différentes | Perfil de aluminio reapretado de dos partes para pasos entre revestimientos con alturas diferentes

Box = 10 Stück/Karton | pieces/box | unités/carton | piezas/cartón | Mindestbestellmenge | minimum order size | commande minimum | pedido mínimo = 1 Stück | pieces | unités | piezas



Uni-Design	1 m	2,7 m	Erhöhungsblock height adjustment block cale de réhausse bloque de elevación	
Stainless steel matt	48100422	48100410	48100502	
Stainless steel polishes	48100423	48100411	48100503	
Sand	48100420	48100408	48100502	
Silver	48100421	48100409	48100503	

VERLEGEUTENSILIEN & REPARATURARTIKEL
 INSTALLATION TOOLS AND REPAIR PRODUCTS
 USTENSILES DE POSE ET DE RÉPARATION
 UTENSILIOS DE INSTALACIÓN Y ARTÍCULOS DE
 REPARACIÓN



Gummihammer | Rubber hammer | Marteau en caoutchouc | Martillo de goma

Art. no. 20021004



Blue Marlin Messer | Blue Marlin knife | Couteau Blue Marlin | Cutter Blue Marlin

Art. no. 20021003



Hartwachs-Reparaturset farbig | Repair set hard wax coloured | Set de réparation cire dure colorée | Set de reparación de cera dura coloreada

Art. no. 10040063

20 Hartwachsstangen à 4 cm Länge in verschiedenen Farben, untereinander mischbar | 20 hard wax sticks, 4 cm length, in various colours, can be mixed with each other | 20 barres de cire dure de 4 cm de longueur dans différents coloris, peuvent être mélangées ensemble | 20 barras de cera dura de 4 cm de largo de diferentes colores, mezclables entre sí



Hartwachs-Reparaturset transparent | Repair set hard wax transparent | Set de réparation cire dure transparent | Set de reparación de cera dura transparente

Art. no. 10040062

Je 3 Stangen Hart- und Weichwachs à 4 cm Länge inkl. 2 Stangen Füllfix à 8 cm | 3 sticks each of hard and soft wax, 4 cm length, incl. 2 sticks of filler (8 cm) | 3 bâtonnets de cire dure de 4 Cms, 3 bâtonnets de cire molle de 4 Cms, 2 bâtonnets de remplissage de 8 Cms | Cada 3 barras de cera dura y blanda, 4 cm largo y 2 barras material de relleno, 8 cm



Montagehilfe | Assembly aid | Aide de montage | Ayuda para le montaje

Art. no. 10030652



Rundschnur | Round cord | Cordon rond | Cable redondo
Art. no. 20080300

Ca. 6mm Ø, 10m Länge, Einlage für Dehnungsfugen, zur Abdichtung mit Acrylmasse | Approx. 6 mm thick foam round cord with a length of 10 m, used as an insert for expansion joints, for professional sealing with acrylic compound | Cordon rond en mousse de 6 mm s' épaisseur et 10 m de long, pour remplissage des joints de dilatation, pour une mise en oeuvre dans les règles de l'art avec une mastique acrylique | Cable redondo de espuma de aprox. 6 mm de grosor y 10 m de longitud como base para juntas de dilatación para asegurar un cierre profesional con masa de acrílo



Profi Gaslöter | Professional gas solderer | Fer à souder au gaz professionnel | Soldador de gas profesional

Art. no. 10040101

Professioneller Gaslöter zur Erwärmung und Verarbeitung von Hartwachs | Professional gas solderer for heating up and processing hard wax | Fer à souder au gaz professionnel pour chauffer et travailler la cire dure | Soldador de gas profesional para calentar y procesar la cera dura



Füllstoffhobel | Filler plane | Rabot pour cire de réparation | Cepillo de material de relleno

Art. no. 10040061

Zum Abhobeln von Füllstoffen, mattieren oder polieren von Wachsüberständen | For proper fine down of fillers, to matt or polish excess wax | Pour le traitement des cires de rebouchage, pour le rabotage, le matage ou le polissage des excédents de cire | Para procesar de forma limpia los materiales de relleno, rebajar, matear o pulir los resaltes de cera

Windmüller GmbH

Nord-West-Ring 21

D-32832 Augustdorf

Tel.: +49 (0) 52 37 609 - 0

Fax: +49 (0) 52 37 609 - 309

info@wineo.de

www.wineo.de

wineo